

NX Advanced Simulation

fact sheet

Siemens PLM Software

www.siemens.com/plm

► Summary

NX™ Advanced Simulation software combines the power of an integrated NX Nastran desktop solver with NX Advanced FEM, a comprehensive suite of multi-CAD FE model creation and results visualization tools. Extensive geometry creation, idealization and abstraction capabilities enable the rapid development of complex 3D mathematical models that allow design decisions to be based on insight into real product performance. NX Advanced Simulation enables a true multi-physics environment via tight integration with NX Nastran as well as other industry standard solvers such as Abaqus, Ansys, MSC Nastran, and LS-Dyna.

Benefits

Build models faster with embedded tools for 3D geometry creation, editing and abstraction

Make design changes easily with Synchronous Technology for quick what-if analysis

Enable faster collaboration between analysts and design engineers with geometry associativity

- Knowledge of design changes
- “On-demand” FE model updates based on design geometry changes

Manage and share your CAE data with support for NX Manager and Teamcenter software for all created FE data sets

Reduce modeling errors and model build time by providing your analysts with a familiar environment – NX environments are customized for the chosen solver

Build models faster with a full range of tools for FE model generation including predefined constraint conditions and automated mesh mating conditions

Reduce rework by verifying models before processing with a full set of graphical and mathematical tools that help check model suitability

View analysis results quickly and easily with a dynamic visualization tool

NX Advanced FEM includes the fundamental modeling functions of automatic and manual mesh generation, application of loads and boundary conditions and model development and checking. NX Advanced FEM includes Assembly FEM technology, a distributed model approach to handle large FEM assemblies. A robust set of visualization tools generates displays quickly, lets you view multiple results simultaneously and enables you to easily print the display. In addition, extensive post-processing functions enable review and export of analysis results to spreadsheets and provide extensive graphing tools for gaining an understanding of results. Post-processing also supports the export of JT data for collaboration across the enterprise with JT2Go and Teamcenter for lifecycle visualization.

NX Advanced FEM provides seamless, transparent support for a number of industry-standard solvers, such as NX Nastran, MSC Nastran, Ansys and Abaqus. For example, when you create either a mesh or a solution in NX Advanced FEM, you specify the solver environment that you plan to use to solve your model and the type of analysis you want to perform. The software then presents all meshing, boundary conditions and solution options using the terminology or “language” of that solver and analysis type. Additionally, you can solve your model and view your results directly in Advanced FEM without having to first export a solver file or import your results.

- Advanced FEM features data structures, such as the separate Simulation (.sim) and FEM files (.fem) that help facilitate the development of FE models across a distributed work environment. These data structures also allow analysts to easily share FE data to perform multiple types of analyses.
- The NX data model is designed to be fast and handle large amounts of data. Duplication of data is avoided and data is placed where it belongs – either on the mesh or on the elements.

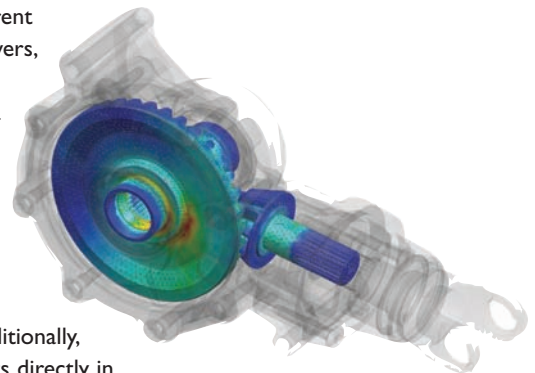

Benefits continued

Gain new insights on design performance with extensive post-processing tools to continue the iterative phases of analysis or to export/import information

Capture and deploy CAE “best practices” through integration with Simulation Procs Studio

Features

Unique and powerful geometry manipulation and abstraction tools

- Fully associative CAD modeling tool set for feature removal and idealization
- Automatic CAE abstraction tools based on desired element size that further refine the geometry to ensure high quality mesh generation with limited user interaction

CAD software interface support for Parasolid® software, JT, STEP and IGES data formats

Intuitive interface with the Simulation navigator for quick and easy access to FE data entities

Complete material definitions support for isotropic, anisotropic, orthotropic and hyperelastic materials

Material catalog with 60 predefined materials

Complete set of load and constraint definitions to support a wide variety of solutions

Support for NX Nastran desktop and enterprise solvers

Support for additional CAE solutions for fluid flow analysis, advanced thermal analysis, advanced durability analysis and design optimization

Support for a variety of external third-party solvers through a unique environment selection based on PLM XML that enables customization of the UI to match the selected solver for element definition through solution setup

Integrated design parameter-based optimization

Integrated basic durability analysis

- NX automatically organizes your model in a logical manner. Meshes are placed in mesh collectors, and your model entities can also be placed in groups. Visibility of these entities can be easily managed in the Navigator.
- NX provides a distributed model approach for analyzing assemblies whereby the Assembly FEM model does not contain the component FEM models, but instead holds pointers to these models. An assembly FEM contains occurrence and position data for multiple component FEMs as well as connection elements that join the component FEMs into a system. The assembly FEM can also contain material and physical property overrides on component FEM meshes.
- Advanced FEM offers world-class meshing capabilities. The software is designed to produce a very high quality mesh while using an economic element count. Advanced FEM supports a complete complement of element types (0D, 1D, 2D and 3D). Additionally, Advanced FEM gives analysts control over specific meshing tolerances that control, for example, how the software meshes complex geometry, such as fillets.
- Advanced FEM includes multiple geometry abstraction tools that give analysts the ability to tailor the CAD geometry to the needs of their analysis. For example, analysts can use these tools to improve the overall quality of their mesh by eliminating problematic geometry, such as tiny edges or slivers.
- Advanced FEM also supports the new NX Thermal and NX Flow solutions
 - NX Thermal is a fully integrated finite difference solver. It allows thermal engineers to predict heat flow and temperatures in systems subjected to thermal loads.
 - NX Flow is a computational fluid dynamics (CFD) solver. It allows analysts to perform steady-state, incompressible flow analysis and predict flow rates and pressure gradients for movement of fluid in a system.

When used in combination, NX Thermal and NX Flow provide fully coupled treatment of convective heat transfer, enabling robust simulation of conjugate heat transfer problems.

FE modeling tools*Getting and using geometry*

Wireframe, surface and solid geometry from other CAD systems can be accessed through embedded standards-based interfaces (IGES, STEP AP203, STEP AP214, Parasolid and JT) or optional direct CAD interfaces for Catia and Pro/Engineer. A complete set of geometry creation and modification tools is provided to work directly with native and non-native geometry. Often design geometry must be modified to build an effective model. Details may need to be suppressed or eliminated, additional geometry may be required to control mesh density; or surfaces not present in the geometry may be needed for meshing. NX Advanced FEM is powered by Synchronous Technology which enables users to modify geometry by easily moving or deleting individual faces or features such as bosses or ribs. Synchronous technology empowers analysts to make simple changes to the idealized geometry to support what-if analyses thereby speeding up design-analysis iterations. Furthermore, this technology works with native and imported geometry, both with or without history.

NX Advanced FEM provides extensive model editing capabilities, including the ability to:

- Interactively suppress features defined within the NX part
- Perform sensitivity analysis using design parameters as defined in the CAD model
- Remove fillets and holes automatically using the idealize command set on both native and non-native geometry
- Add, modify or delete entities (sheet body, solid body)

- Extract the mid-surface representation directly from the solid body for modeling thin walled components; surface thickness is mapped from the solid to the 2D representation
- Powerful commands to partition and split bodies
- Automatically support the relationships between the component CAD model and the FE model within NX Manager and Teamcenter

Abstracting CAD for FE meshing

Often CAD topology contains details that are of no use to the analyst. Sliver surfaces, detailed embosses (e.g., “Made in U.S.A.”), small fillet radii and small holes are examples of details the analyst may not wish to mesh. There are multiple tool sets to abstract and idealize the geometry for model preparation.

Idealize commands are provided to allow the user to remove and suppress design features like holes and fillets. This can be done on NX native or non-native 3D CAD geometry. This set of powerful tools allows the user to change the design geometry without the need to own the original geometry.

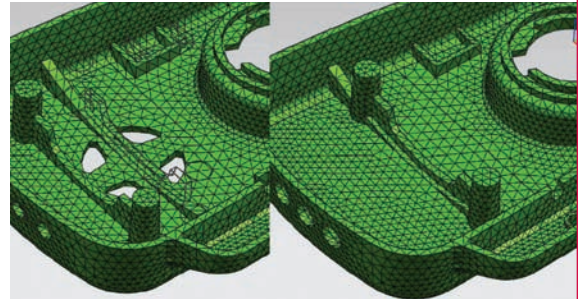

Abstraction commands are provided in the FEM for removal of design artifacts such as sliver faces, small edges and isthmus conditions. It does not remove the actual design features but rather allows for the removal of geometry artifacts that affect the overall quality of the mesh. This set of commands allows the analyst to mesh the geometry at a level of detail that sufficiently captures the design intent relevant to a particular FE analysis.

NX abstraction technology supports non-manifold geometry, which means an edge can be shared by more than two faces and a face can be shared by more than one body. True support for non-manifold geometry ensures robust meshing between adjoining geometry, and removes any meshing limitations typically encountered in manifold-only environments.

A key concept is that the CAE-driven modifications, either idealized or abstraction, do not change the original design geometry and are completely associated, allowing the user to accept modification to the design geometry without the need to rebuild the FE modeling intent.

Meshing

Powerful abstraction and meshing technology allows a user to free mesh any 2D or 3D solid or sheet body or ID type elements, curves or edges. A rich set of tools is provided for joining meshes together, including easy-to-use geometry-based methods such as point-to-point, edge-to-edge, point-to-edge, point-to-face, edge-to-face, and face-to-face methods. Elements created by geometry-based methods are automatically re-created when their parent components are re-meshed. In addition, FE-based connections (i.e., node-to-node) can easily be made using the powerful selection methods available in NX Simulation.

Free meshing capabilities include:

- Automatic meshing of surfaces and of volumes, with no topology restrictions
 - 3D tetrahedral
 - 3D swept mesh

- 2D mesh
 - 2D mapped meshing available with 2D free meshing
 - Sweep meshing “paver”
 - 2D meshing boundary
 - 2D dependent boundary
 - Quad-only meshes
- 1D mesh
 - Beam
 - Rigid
 - Spring
 - Gap
 - Damper
- Transition meshing from fine to coarse for 2D and 3D free meshing
- NX supports pyramid elements, which are needed to smoothly transition from a hex mesh to a tetrahedral mesh
- User controlled automatic abstraction during meshing
- Surface meshing with linear or parabolic quadrilaterals, triangles or quadrilateral dominant meshes that insert triangles in a quadrilateral mesh to automatically reduce element distortions
- Solid meshing with linear, parabolic tetrahedral elements
- Ability to define allowable distortion for tetrahedral elements before meshing
- Local element control for precise mesh generations
 - Number of elements on edge
 - Chordal tolerance
 - Geometric progression
- Geometry-based definition and generation of lumped masses, rigid bars, spring, gap and damper elements
- Association of mesh generation settings with geometric features (updates occur with design geometry changes)

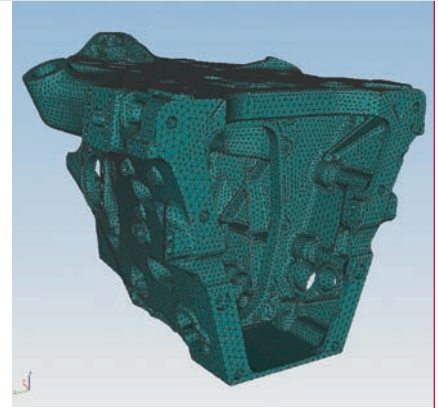

Element library

A complete library of finite elements lets you perform many types of analysis and modeling quickly and efficiently. More than 125 standard element types are provided, including linear and parabolic forms of shells and solids, axisymmetric shells and solids, beams, rods, springs, dampers, masses, rigid links and gaps. Scalars and other special elements have unique graphic symbols. P-elements (solid tetrahedra) are supported for linear structural analysis.

Beam section properties

Beam section properties may be defined from a standard set of sections or directly from CAD geometry simplifying the task of generating the appropriate data for the beam definition.

Loads and boundary conditions

NX Advanced FEM provides extensive capabilities to define loading and boundary conditions to correctly simulate operating environments:

- Loads can be defined on and associated with geometry. The creation of the load will ensure a node is placed at the location during automatic meshing.
 - Mesh point
 - Face
 - Edge
 - Curve
- Restraints defined on and associated with geometry
 - Mesh point
 - Face
 - Edge
 - Curve
- Support for surface-to-surface contact definitions
 - Surface-surface glue contact
 - Automatic face pairing
 - Coupling
 - Automatic coupled DOF
 - Manual coupled DOF
- Constraints and restraints, including nodal displacement
- Structural loads
 - Nodal forces and temperatures
 - Element face and edge pressures
 - Acceleration (gravity, translation, rotation)
 - Ambient and reference temperatures
- Heat transfer loads
 - Nodal and distributed heat sources
 - Face and edge fluxes, convection and radiation
- All loads and restraints displayed with unique graphical symbols
- Associativity of geometry-based loads and restraints is maintained through design geometry changes
- Definition of time-varying loading and boundary conditions to correctly simulate nonlinear loading conditions
- NX provides a powerful “field” utility which can be used to define loads by expression, array, or table input. Spatial-varying loads can be quickly and easily defined via expression or by ascii file import. The same is true for time, frequency, and temperature dependent loads.

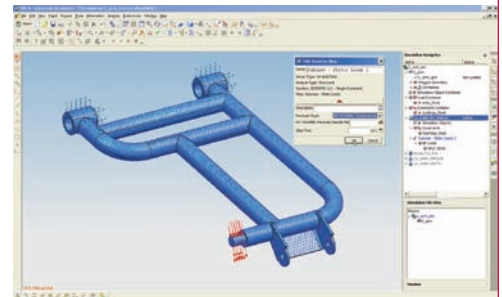
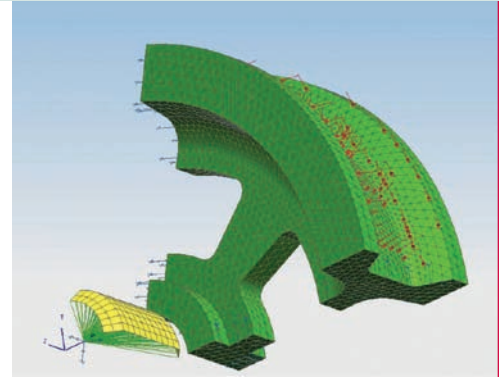

Complete model checking tools

Analyzing a model with errors can be time-consuming and expensive, and errors are often not detected even after analysis. NX Advanced FEM provides a full set of graphical and mathematical tools to help verify that a model is complete and correct before you submit it for solution:

- Coincident node and element checks eliminate duplications
- Free-edge and face checks avoid unwanted cracks in a model

- Shrink element display verifies that elements are located properly
- Element shape checks (distortion, warping, etc.) verify that elements do not violate limits and can produce accurate results
- Element thickness display to check that shell thickness is correct

Getting the best results from analysis

For the mixed science and art of analysis to impact design decisions, results must be presented in an understandable form. NX Advanced FEM provides extensive graphics and manipulation capabilities that focus on critical data and present it for review and action. A comprehensive and flexible methodology has been adopted to enable the user to act before, during and after FEM solutions are sought.

Using NX Advanced FEM, you can:

Create:

- Animated, stepped or smooth-shaded displays
- Cutting plane, contour, element and arrow displays
- Templates of display options for repeated use
- Groups of elements can be created using search criteria e.g., top 30 stress values

Control:

- How data is displayed (for example, data components and coordinate system to use averaged and unaveraged data)
- Text, headers and colors

View:

- Multiple results simultaneously
- Results in multiple viewports
- Deformed geometry
- Streamlines, ribbons and bubbles can be displayed and animated for Flow results
- The display can be reduced to show only a group of elements

Insert:

- 3D probe results annotations
- 3D and 2D text annotations

Export:

- Displays for report-ready printing/plotting
 - JT
 - PNG
 - JPEG
 - GIF
 - TIFF
 - BMP
 - Animated GIF
- Single or multiple result sets to spreadsheets or directly to Excel (Windows only) for further manipulation

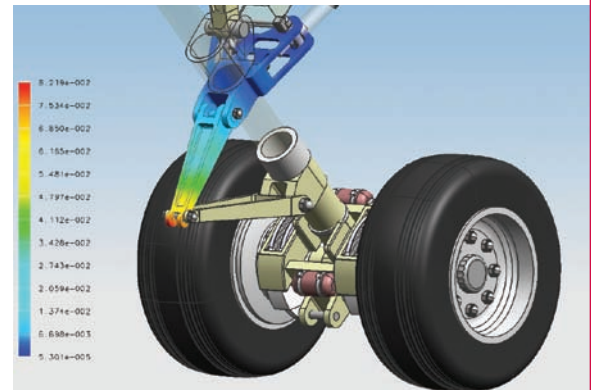

Report generation

- HTML customized report generation for model data and results inspection

Import:

- Nastran OP2
- Abaqus FIL
- Ansys RST
- I-deas UNV and BUN

Optional solver environments

The NX Advanced FEM user layout is driven by the solution environment or language chosen by the user. This environment is customized to immerse the user in the language of the selected solver. From element and loading terminology to the appropriate loads and constraints available for the solver are all controlled by the solver language.

All environments are available to the user but import and export of FEA data is controlled by an optional solution environment add-on module for solvers such as Abaqus, Ansys, Nastran, LS-Dyna, etc. The Nastran Solution Monitor helps the user monitor the solver job status and track errors with the solve.

The solution environments currently supported by the NX Advanced FEM product include:

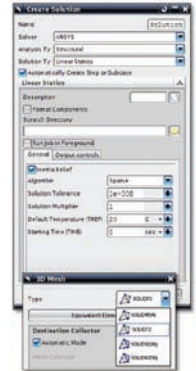

Solver	Analysis type	Solution type
Nastran	Structural	Linear statics (SOL 101) with surface-to-surface contact
		Normal modes (SOL103)
		Response simulation (SOL 103)
		Buckling (SOL 105)
		Nonlinear statics (SOL 106)
		Direct frequency response (SOL 108)
		Direct transient response (SOL 109)
		Modal frequency response (SOL 111)
		Modal transient response (SOL 112)
		Advanced nonlinear (SOL 601)
Advanced nonlinear explicit (SOL 701)		
Linear and advanced nonlinear transient response (SOL 129)		
	Thermal	Heat transfer (SOL 153)
	Axisymmetric structural	Linear statics (SOL 101) Nonlinear statics (SOL 106)
	Axisymmetric thermal	Heat transfer (SOL 153)

<i>Solver</i>	<i>Analysis type</i>	<i>Solution type</i>
Abaqus	Structural	General analysis
	Thermal	Heat transfer
	Axisymmetric structural	General analysis
	Axisymmetric thermal	Heat transfer
Ansys	Structural	Linear statics
		Modal
		Buckling
		Nonlinear statics
	Thermal	Thermal
	Axisymmetric structural	Linear statics Nonlinear statics
	Axisymmetric thermal	Thermal
NX Thermal and NX Advanced Thermal	Thermal	Finite difference thermal (based on TMG)
NX Flow	Fluid flow	Incompressible computational fluid dynamics (CFD)
	Coupled thermal/flow	Coupled
NX Advanced Flow	Fluid flow	Compressible computational fluid dynamics (CFD)

Features

- Powerful analysis capabilities
- Complete element library including spot welds
- Full range of material models
- Easy combination and addition of load cases
- Comprehensive array of Eigensolvers
- Design sensitivity analysis for assessing design changes
- Efficient solvers
- Comprehensive thermal analysis capabilities
- Basic nonlinear capability for large displacement and material nonlinearities
- Surface-to-surface contact for linear static solutions
- Glue connections for joining dissimilar meshes

NX Nastran – Desktop

The Advanced Simulation bundle includes a license of the NX Nastran – Basic desktop solver integrated with a desktop license of the NX Nastran Environment translator. The NX Nastran – Desktop Advanced bundle and/or individual modules for NX Nastran listed below can be added on to a seat of NX Advanced Simulation.

NX Nastran – Basic provides access to a broad library of finite element types and material models, robust manipulation of load cases, along with several efficient solution sequences for linear statics, buckling and normal modes analyses on models of unlimited size. A heat transfer capability provides solutions to steady-state and transient thermal analysis and design problems. A basic nonlinear capability enables including large deformation and material nonlinear effects in the solution.

<i>NX Nastran analysis feature and capabilities</i>	<i>Basic bundle</i>	<i>Advanced bundle*</i>	<i>Available separately</i>
Basic analysis capabilities			
Linear static analysis	•		
Normal modes analysis	•		
Buckling analysis	•		
Heat transfer analysis (steady-state and transient)	•		
Basic implicit nonlinear analysis	•		
Spot weld analysis	•		

<i>NX Nastran analysis feature and capabilities</i>	<i>Basic bundle</i>	<i>Advanced bundle*</i>	<i>Available separately</i>
Advanced analysis capabilities*			
Distributed memory parallel capability (DMP)**		•	•
Dynamic response analysis module		•	•
Advanced nonlinear analysis module			•
Superelements analysis module		•	•
Direct matrix abstraction programming (DMAP)		•	•
Design optimization module			•
Aeroelasticity analysis module		•	•
Advanced aeroelastic module			•
Rotor dynamics			•

* Basic bundle is a prerequisite for all add-on modules and the Advanced bundle. The Advanced bundle is not available in the desktop version that is integrated with Femap® software, but the individual advanced analysis modules can be purchased as add-ons to Femap and NX Nastran Basic.

** DMP is not available in desktop versions.

Solution processes

NX Advanced FEM also supports the definition of solution processes, which represent a multi-step solution and work with any of the supported structural solvers. The following processes are supported in Advanced FEM: adaptive, durability and optimization.

Adaptive solution

Adaptive analysis is a linear statics solution option, available for all supported solvers, that uses a solver-independent h-adaptive analysis method to perform automatic mesh refinement during solve iterations. The main objective of adaptive analysis is to automate the lengthy and repetitive process of running multiple finite element analyses with different mesh densities. The mesh refinement is determined by error estimates associated with element stress discontinuity. Based on these error estimates, critical regions are identified on the model, which then become the target for further refinement of the mesh.

Once the critical regions are identified, the local refinement is implemented internally. An element sizing scheme is used to estimate the new size. Furthermore, element quality is checked along transition areas to eliminate false hot spots that may later influence the refinement process.

Adaptive analysis is supported for all 2D and 3D triangular elements. Hex, wedge and pyramid elements are not supported. During the adaptive solve, the refinement of existing mesh elements involves replacement by matching template patterns. Element nodes needing refinement are identified by the software and modified accordingly.

Durability

Structural fatigue analysis is a tool for evaluating a design's structural worthiness, or its durability, under various simple or complex loading conditions, also known as fatigue duty cycles. NX Advanced FEM supports the creation of a durability process solution. Results of a fatigue analysis are displayed as contour plots that show the duration of cyclic loading (number of fatigue duty cycles) the structure can undergo before crack initiation occurs.

Fatigue analysis uses the cumulative damage approach to estimate fatigue life from stress or strain time histories. Estimation is accomplished by reducing data to a peak/valley sequence, counting the cycles and calculating fatigue life. A library containing standard fatigue material properties is provided.

Optimization

Optimization is a process that helps the analyst arrive at the best solution for a given design goal. NX Advanced FEM allows the user to create an optimization solution process. The user can define a goal such as the mass of a part or component, a constraint such as maximum allowable Von Mises stress and the design parameter(s) to vary on the component. The optimization solution process will run based on the design criteria while varying the design parameters to enable the design engineer to determine if there is a better structural design alternative vs. the original baseline design.

Product availability

NX Advanced FEM is a core package in the suite of NX Advanced Simulation add-on applications available within the Siemens Lifecycle Simulation architecture. It is a prerequisite for all other solution applications in the NX Advanced Simulation suite such as NX Nastran Desktop, NX Flow, NX Thermal, NX Electronic Systems Cooling, NX Space Systems Thermal, NX Response Simulation, NX Laminate Composites and the customized solver environments for Nastran, Ansys and Abaqus.

NX Advanced FEM is available on 32 and 64-bit Windows and also on 64-bit Linux systems.



Contact

Siemens PLM Software

Americas 800 498 5351

Europe 44 (0) 1276 702000

Asia-Pacific 852 2230 3333

www.siemens.com/plm