

## **NX Nastran:**

World-class performance, reliability  
and scalability

Siemens PLM Software

[www.siemens.com/plm](http://www.siemens.com/plm)

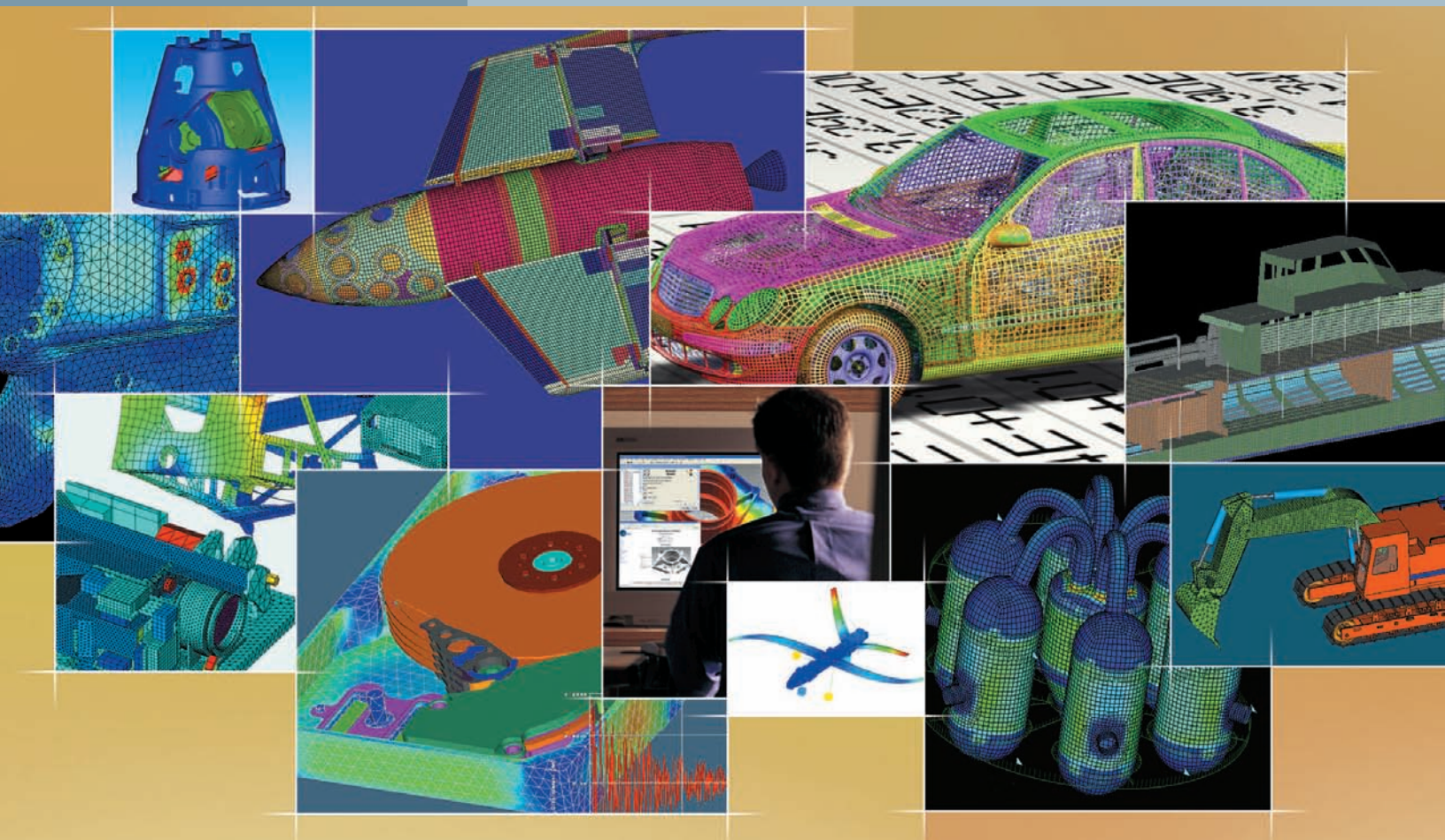

NX™ Nastran software is core to Siemens PLM Software's strategy. Developing and delivering engineering technology, recognized and trusted by the most demanding of our customers, is the foundation of our whole PLM portfolio. Siemens is embedding NX Nastran simulation technology across the portfolio to expand the number of users who can safely utilize the technology, thus increasing the value our customers get from our solutions.

**NX**

**SIEMENS**

### Why digital simulation?

Industry pressure to reduce costs and improve quality is driving growth in the use of digital simulation throughout the product lifecycle.

Choosing the right tools is key to achieving the business benefits of digital simulation. Companies need to consider technology, scalability, integration and management.

- The right technology ensures that digital simulation can accurately represent the physical environment.
- Scalable solutions adjust to a broad range of users skill levels and a growing scope of requirements.
- Integration with other simulation tools and with product development applications is important to both the efficiency and effectiveness of the CAE solution.
- Management of data, processes, product knowledge and workflows is critical to overall enterprise efficiency and collaboration.

### Why Siemens PLM Software?

NX helps manufacturers develop products right the first time with a complete range of simulation, validation and optimization tools. At every stage of development, these integrated tools check products and processes to ensure quality, performance and manufacturability.

#### Product quality with fewer prototypes

With NX digital simulation, companies accurately model and analyze product performance characteristics while minimizing physical prototypes.

NX product simulation applications include dynamic motion simulation, basic strength analysis, system-level performance evaluation and advanced response, durability, fluid flow and multi-physics engineering analysis for robust simulation of functional performance.

NX also manages CAE processes, workflows and data to deliver vital performance feedback where it is needed to improve your products.

> **A competitive advantage**

#### Your business benefits

- ▶ Faster to market with innovative new products
- ▶ Lower costs from:
  - physical prototyping
  - engineering change orders
  - in-service warranty
- ▶ Increased product quality

# A CAE technology leader

Siemens is a world leader in digital prototyping and simulation (CAE). Our solutions are backed by an experienced staff of engineering analysis experts and a distinguished 40-year history of developing leading-edge digital simulation technologies. The Siemens team has a unique vision to take the digital simulation community into the future at the heart of digital product development.

### Simulation for the enterprise

High numerical performance and robust product simulation capabilities are key to NX Nastran. It has been successfully deployed across many industries as an enterprise-wide solver including aerospace, automotive, electronics, heavy equipment and medical. It provides comprehensive product performance simulation in a broad range of engineering disciplines, including stress, displacement, buckling, failure, vibration, shock, heat transfer, acoustics and aeroelasticity.

Simulation, validation and optimization capabilities are a pervasive attribute of the NX product portfolio. Siemens strategy is to develop simulation technology for the most demanding engineering analyst and then package it to enable a wider community to use and benefit from it.

### PROVEN RESULTS

► *“NX Nastran is very significant for Siemens. It is visible proof of the energy and commitment of our development team in delivering customer requested enhancements and capabilities that will be used around the world. We believe our customer-centric approach provides competitive advantages for our customers.”*

*Chuck Grindstaff  
Executive Vice President  
Siemens PLM Software*

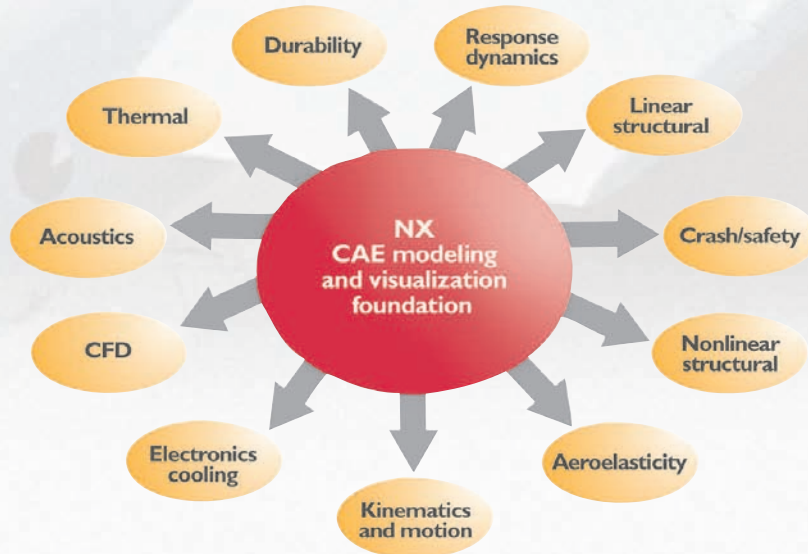

► **Comprehensive  
and  
complementary**

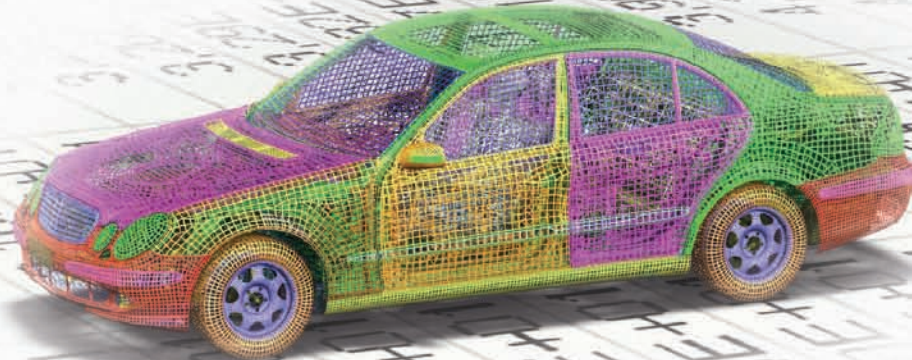

Image Courtesy of Daimler AG

# The value of NX Nastran technology

Digital simulation is credited with driving millions of dollars out of R&D costs because building a computer model and digitally testing performance is faster, cheaper and more effective than the physical prototyping processes it replaced. By rapidly evaluating many more concepts, engineers and designers have the information to design better products, faster and with less cost.

NX Nastran is exercised, tested and proven every day by some of the world's most demanding CAE analysts. Our customers are at the forefront of the industry. They work with some of the world's largest and most complex problems. They demand and expect the reliability, robustness and power that NX Nastran delivers.

## Linear analysis

Linear static analysis assumes that materials are not strained beyond their limits and that deformations remain small in relation to overall dimensions. NX Nastran features a complete range of linear functionality. It can help you solve problems that are static, like snow lying on a roof or problems where something changes over time, like a car driving down a road. It can also be used to solve for buckling load capacities and heat transfer behavior. From a practical and computational viewpoint, linear analysis is the most effective approach for evaluating many design issues.

## Advanced nonlinear analysis

When deformations become large, linear material assumptions are invalid or contact is a factor, then nonlinear analysis is the appropriate choice. Nonlinear analysis enables users to address problems as simple as a plastic catch and as complex as a car body roof crush and post-buckling analysis used for a ROPS (roll over protective structure) strength simulation. Advanced material capabilities enable users to simulate the collapse of a rubber mount or the performance of an engine gasket seal. Dynamic capabilities enable users to see what happens to electronic hardware during a drop test. An integrated explicit dynamic solution option is used for very high impact simulations such as drop simulations and metal forming analysis.



Image courtesy of Nissan Rally Raid Team

## Rotor dynamic analysis

Rotating systems, such as shafts and turbines, are subject to rotation induced gyroscopic and centrifugal forces that give rise to dynamic behavior not present in stationary systems. In particular, dynamic instability can occur at certain rotation speeds known as critical speeds. Rotor dynamic analysis allows engineers to predict critical speeds for their systems and develop designs that operate away from these unstable speeds.

The advanced nonlinear capabilities in NX Nastran have proven their value in industry for many years. They are developed to address the most complex static and time-dependent problems including surface-to-surface contact, large deformation, elastic-plastic, hyperelastic or gasket materials and more.

## Dynamics

Dynamic analysis is important and a known strength of NX Nastran. From transient, to frequency, to random loading, to shock response, NX Nastran covers the full range of dynamic solutions. Further, this is a capability where raw performance adds significant value, and NX Nastran provides an extensive array of options and capabilities that get the job done.

Siemens PLM Software has extended testing procedures in the Nastran build process and validates the interface to partner solutions like AMLS (automated multi-level substructuring), a product used by automotive OEMs for car body NVH analysis. In other cases, direct links have been developed to simplify working with other analysis products such as ADAMS and RecurDyn. This increases efficiency and eliminates opportunities for user error. Users benefit from simpler-to-use capabilities that are faster, more accurate and versatile.

## PROVEN RESULTS

► *“The virtual development of premium passenger cars consequently requires premium analysis tools. After one year of cooperation with the NX Nastran development team, I am pleased that our confidence has been well rewarded. Our full-vehicle NVH knowledge and expertise, combined with the experience and high standards of Siemens numerical analysts, have enabled many unique advanced NX Nastran tools and ever more intelligent, complete solutions for our products and conceptions.”*

*Full-Vehicle Dynamic Analyst  
Daimler AG*

### Direct matrix abstraction programming (DMAP)

In essence a simple programming capability, DMAP provides enormous customization flexibility. Standard problems solved with NX Nastran do not require the usage or knowledge of DMAPs. But for the advanced user, who has special solution needs, DMAPs provide the ability to modify or create solutions. Often DMAPs are used in enterprise operations where program managers need to integrate systems-level models. Examples of its many uses include modifying solution flow, avoiding problems, integrating new capabilities, outputting specific data for review or ongoing analysis. DMAP is unique to Nastran and key to its value in many companies.

### Integration

Siemens strategy is to develop NX Nastran for the most advanced and demanding users. The same robust capabilities are then leveraged and repackaged with other NX and Femap® software capabilities to

enable a wider user community to benefit. Solver and graphics teams work closely together ensuring that enhancements to NX Nastran capabilities are rapidly supported by corresponding advances in NX and Femap.

In aerospace development, advanced analysis leads design. Complex interactions within the flight system create severe loads that drive the design of subsystems and components. Quartus Engineering Inc. was selected by the Paul Allen/Scaled Composites team to help in the development of the first private manned space capability. They provide flutter analysis and ground vibration test services that enhance the goal of developing a safe space vehicle at the minimum possible flight operating cost. Quartus selected NX Nastran for the same reason.

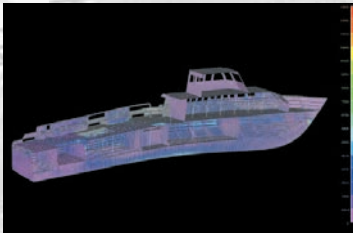

Shipbuilding images courtesy of Damen Shipyards, Netherlands

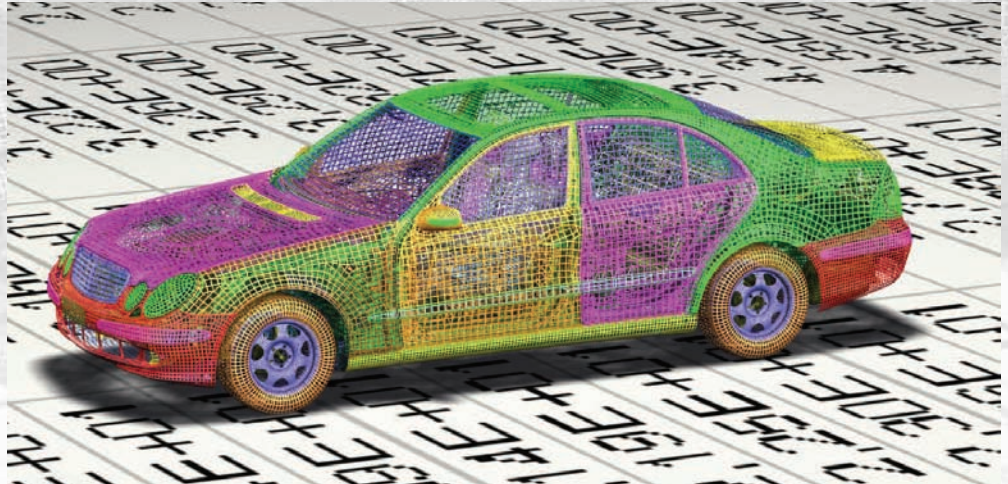
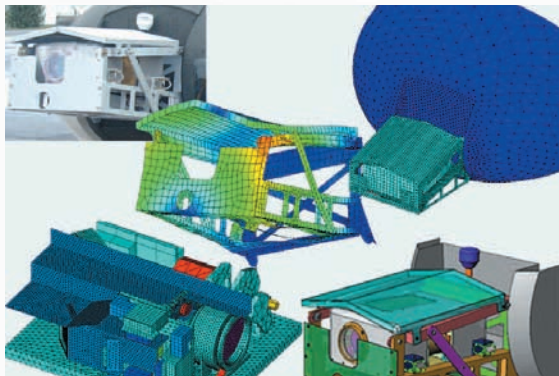

Image Courtesy of Daimler AG



Images courtesy of Trex Enterprises and ATA Engineering Inc.

### PROVEN RESULTS

- ▶ *“NX Nastran has been widely implemented in the industry as a standalone enterprise simulation capability, and represents a clear technical focus for the Siemens development team. By embedding this technology within customer process environments, engineers and analysts at all levels find it an effective solution. As a result, we are seeing a significant increase in the use of digital simulation technology, which makes very good business sense for our customers.”*

*Jim Rusk  
Vice President  
NX Digital Simulation  
Siemens PLM Software*

# Development philosophy – a commitment

## Computational power means rapid response

Large system-level dynamic analyses, often seen in the automotive and aerospace industries, are a major computational challenge. In NX Nastran, Siemens implemented a hierarchic distributed memory parallel (HDMP), a robust Lanczos solution that combines the frequency and geometry domain DMP Lanczos solution into a simultaneous execution. Intended to be used on clusters of workstations, it delivers dramatically improved scalability – making NX Nastran the most scalable Nastran solution on the market.

When it comes to rapid turnaround, iterative solvers are clearly superior to sparse solvers for many types of problems. The element-based iterative solver in NX Nastran is vastly superior to the global matrix approach in previous versions and regularly demonstrates

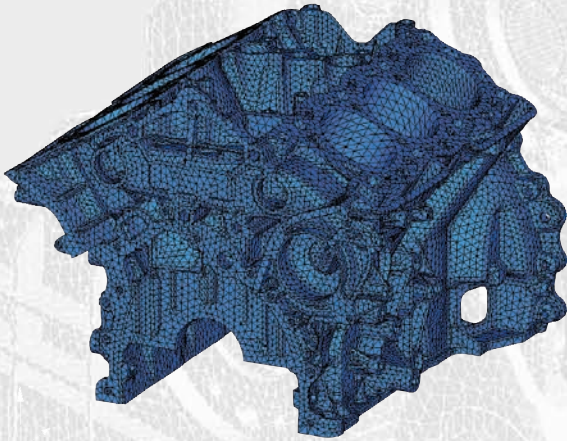

4x to 10x solution time improvements over the sparse alternative. The benefits for large solid element dominated models, like those used for engines, are obvious but many other components used in everyday products benefit from this approach.

NX Nastran – large model performance

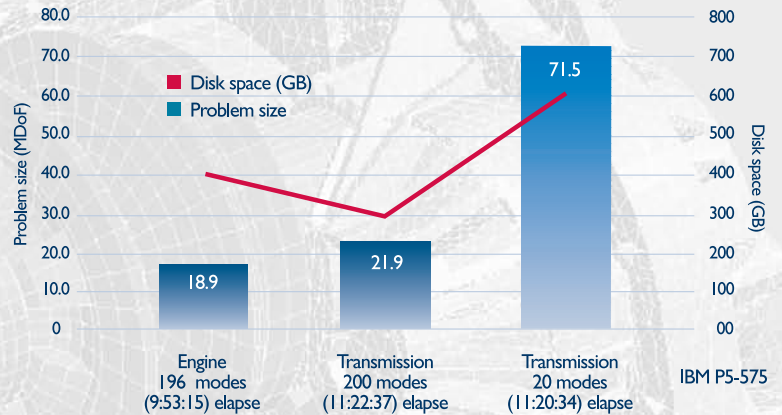

Solving the largest numerical challenges is critical to the ability of engineering analysts to positively impact design decisions and a key focus for Siemens development and research.

## PROVEN RESULTS

► *“Solution performance, a hallmark attribute of Nastran, is a key differentiator for NX Nastran. Solving the largest numerical challenges is critical to the ability of engineering analysts to positively impact design decisions and is a key focus for Siemens development and research.”*

*Dr. Louis Komzsik  
Chief Numerical Analyst  
Nastran Development  
Siemens PLM Software*

Normal modes performance

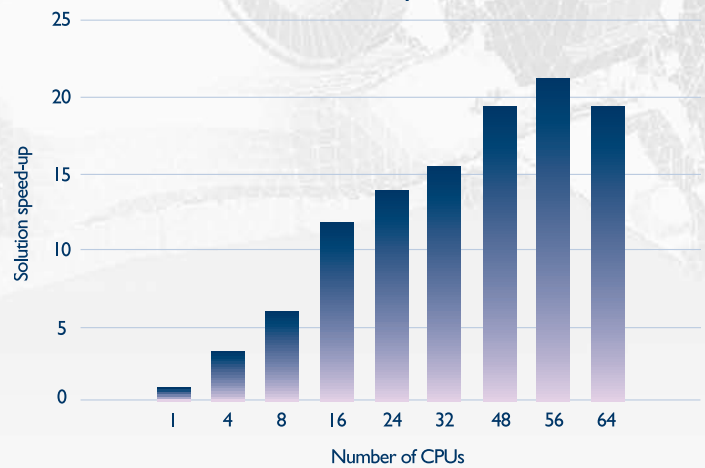

Trimmed car body – 2.3 million degrees of freedom, 380,000 node points, 900 mode shapes  
IBM P650 workstation cluster 64 POWER4 (1.5 GHz) CPUs

### Continuous enhancement in all areas of the code

NX Nastran connectivity modeling, element families and modeling processes have continual improvements and extensions with each release. For connectivity modeling NX Nastran has added:

- Linear contact
- Glue connections for joining dissimilar meshes
- Bolt preloading
- Thermal expansion for rigid elements

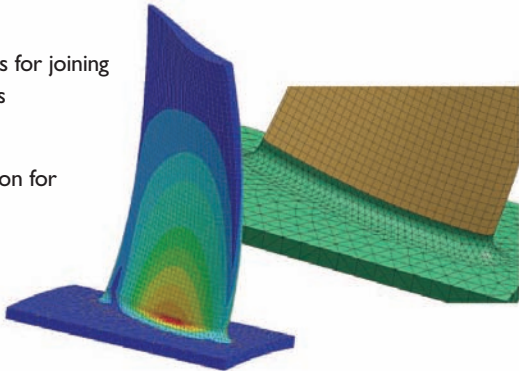

Some of the element improvements in NX Nastran are:

- Enhanced CQUADR/CTRIAR elements to support differential stiffness for buckling analysis and coupling of membrane and bending stiffness for laminate analysis
- Enhancements to PSHELL entry allow users to specify corner thicknesses in relative terms, greatly simplifying the use of shell thickness when optimizing products

- New axi-symmetric elements including linear and parabolic quad elements
- Extensions to the CWELD element to make it easier to connect multiple elements

Process improvements that have been added are:

- Easier to use external superelements
- Automatic resolution of dependency conflicts
- Direct interfaces to MBD solvers for flexible bodies

### From PCs and traditional hardware companies to street-built clusters

Performance is important to NX Nastran customers. The evolution of hardware architectures and their impact on accelerating available compute performance makes it an area for continuous focus and improvement. DMP versions are available for most platforms including both 64-bit and 32-bit systems operating under Linux.

Siemens PLM Software supports Unix, Linux and Windows-based platforms including:

- Unix – HP, IBM, Sun
- Linux – HP Itanium, Opteron, SGI, Intel EM64T
- Windows – 32-bit and 64-bit

NX Nastran analysis feature and capabilities	Basic bundle	Advanced bundle*	Available separately
<b>Basic analysis capabilities</b>			
Linear static analysis	●		
Normal modes analysis	●		
Buckling analysis	●		
Heat transfer analysis (steady-state and transient)	●		
Basic implicit nonlinear analysis	●		
Spot weld analysis	●		
<b>Advanced analysis capabilities*</b>			
Distributed memory parallel capability (DMP)**		●	●
Dynamic response analysis module		●	●
Advanced nonlinear analysis module			●
Superelements analysis module		●	●
Direct matrix abstraction programming (DMAP)		●	●
Design optimization module			●
Aeroelasticity analysis module		●	●
Advanced aeroelastic module			●
Rotor dynamics			●

\* Basic bundle is a prerequisite for all add-on modules and the Advanced bundle. The Advanced bundle is not available in the desktop version that is integrated with Femap, but the individual advanced analysis modules can be purchased as add-ons to Femap and NX Nastran Basic.

\*\* DMP is not available in desktop versions.

# Support and documentation

Siemens is well recognized for the dedication, professionalism and efficiency of their worldwide support team. The Global Technical Access Center (GTAC) is the focal point for post sale software support. It provides both application and operating systems software support through telephone and electronic access. While telephone support provides direct access to experienced support engineers, customers have the option to open any incident report (IR) electronically with full transfer of electronic data into the GTAC call tracking system. In this case, they will be immediately notified of their IR reference number used for all followup, which will typically be either by e-mail or telephone. An online call status tool allows direct access at any time to the support database for the latest status of reported issues while a secure authorization scheme controls access and serves to guarantee the privacy of all customer data.

GTAC is organized into specialized teams which support specific product disciplines. These teams are located in close proximity to their parallel product development groups, so they can quickly locate the path that will lead you to improved productivity. Electronic forums for products are also available enabling users to ask questions and get responses from other users, GTAC support staff, developers, technical sales support and marketing.



▶ Siemens believes that access to a live support engineer or specialist is important and therefore measures all aspects of support to ensure world-class quality and responsiveness.

The bottom line is that it's not about the software...it's about realizing your business goals.

## Documentation

Clear, concise documentation that is informative, easy to use and has a logical place for critical information is key to usability. The NX Nastran documentation has been, and is continuing to be, significantly rewritten to make it more effective and help new users get up to speed more quickly. Clear, concise and effective documentation is a core factor in establishing NX Nastran as the standard for all other Nastrans to be measured against.

## Quick reference guide

The NX Nastran quick reference guide is available as a printed, two-volume guide that provides comprehensive information on using Nastran executive control, case control and bulk data entries. It is also searchable in an electronic format on the NX Nastran online help library CD-ROM.

## Online help library CD-ROM

The NX Nastran online help library CD-ROM contains electronic (pdf) versions of all the manuals available for NX Nastran. An html-based virtual bookshelf allows you to easily access the following documentation.

- Installation and operations guide
- Release guide
- Getting started with NX Nastran
- Element library reference
- Quick reference guide
- NX Nastran users guide
- Basic dynamics users guide
- Thermal analysis users guide
- Design sensitivity and optimization users guide
- Handbook of nonlinear analysis
- Superelements users guide
- Aeroelasticity users guide
- DMAP users guide
- Nastran theoretical manual
- Numerical methods users guide
- Advanced nonlinear theory and modeling guide
- Parallel processing users guide
- Rotor dynamics users guide



# Openness and partnerships

Siemens is proud of its reputation for listening to customers and working with them to set development priorities. Often relatively simple enhancements can save users enormous amounts of time and effort. For example, in the case of modal transient solutions, Siemens added the ability to sort results based on maximum and minimum values. In the past, users had to save results at all times and post-process outside of Nastran to determine maximum values. With this implementation, the amount of results data that needs to be stored for output is vastly reduced, and additional post-processing steps outside of Nastran are no longer needed.

Siemens looks to a core advisory group made up of leading customers in each industry to help define future NX Nastran product strategy. Implementation of core technology is the domain of a highly experienced team comprised both of Siemens and selected software development partners. For many advanced customers, the

long term value of Nastran is not only derived from the robustness, consistency and openness of core capabilities. Many customers have invested in tools developed by third parties that leverage Nastran development. Siemens is committed to maintaining the open and productive nature of relationships with a wide variety of independent developers working to develop customer and industry specific functionality on top of NX Nastran.

## PROVEN RESULTS

► *“Today’s advanced NVH analysis applications require seamless integration of special-purpose proprietary software tools into the analysis process. NX Nastran has set new standards in access to and exchange of Nastran finite element data. This enables us to extract maximum benefit from the CAE tools at the heart of the virtual development process.”*

*Dr Otto Gartmeier  
Manager, NVH CAE  
Daimler AG*

> **Consistency,  
compatibility and  
reliability**

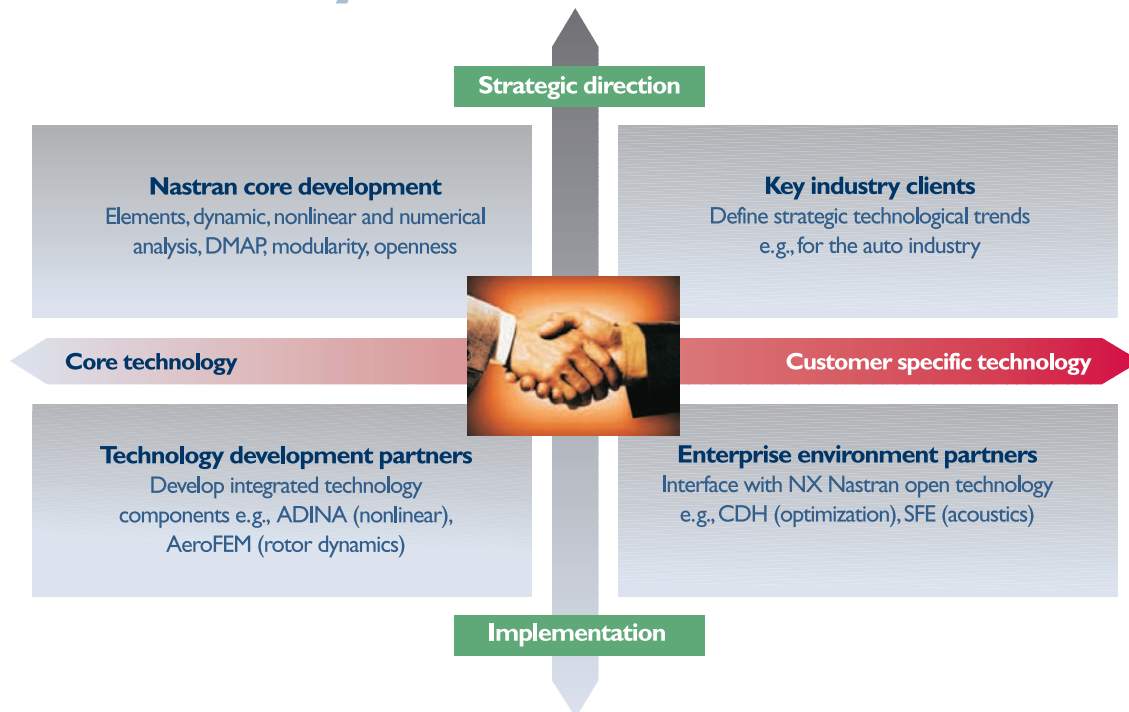

**NX Nastran development ecosystem**

# Siemens digital simulation solutions

Siemens is a single source for all your engineering desktop design simulation solutions as well as enterprise-level, multi-CAD advanced simulation solutions.

## > Robust

### Process and data management applications

- ▶ **Teamcenter® software for simulation process management:** A CAE-specific Teamcenter module that enables the capture, re-use and sharing of CAE data, CAE product structure and CAE processes across the enterprise

### Advanced simulation applications

- ▶ **NX Nastran:** Available standalone as an enterprise solution or seamlessly integrated at the core of many NX Simulation products. NX Nastran delivers comprehensive performance simulation capabilities for a broad range of engineering disciplines and industries. Siemens is dedicated to making NX Nastran the most complete and powerful solution available for functional digital prototyping and simulation.
- ▶ **NX Advanced Simulation:** An open, multi-CAD and CAE solver-neutral environment that enables rapid simulation as an integral part of the design process. Extensive geometry idealization and abstraction capabilities support rapid model simulation in a geometrically complex, multi-physics environment. Powered by an integrated NX Nastran desktop solver, users have direct access to comprehensive model review, structural optimization and results visualization capabilities to enable design decisions to be based on insight into real-world product performance.
- ▶ **NX Advanced FEM:** The power and functionality of NX Advanced Simulation for customers who wish to use an alternative solver (does not include NX Nastran).
- ▶ **NX Laminate Composites:** An add-on capability to NX Advanced Simulation that enables the evaluation of products made with laminate composite materials.
- ▶ **NX Response Simulation:** An interactive, visual environment for the linear evaluation of the structural dynamic response of a system when subjected to complex loading conditions such as random vibration, transient, harmonic and shock spectra.
- ▶ **Customized Environments for Ansys, Abaqus and Nastran:** Add-ons to NX Advanced FEM that tailor the FE modeling and analysis process in language specific to the FE solver.

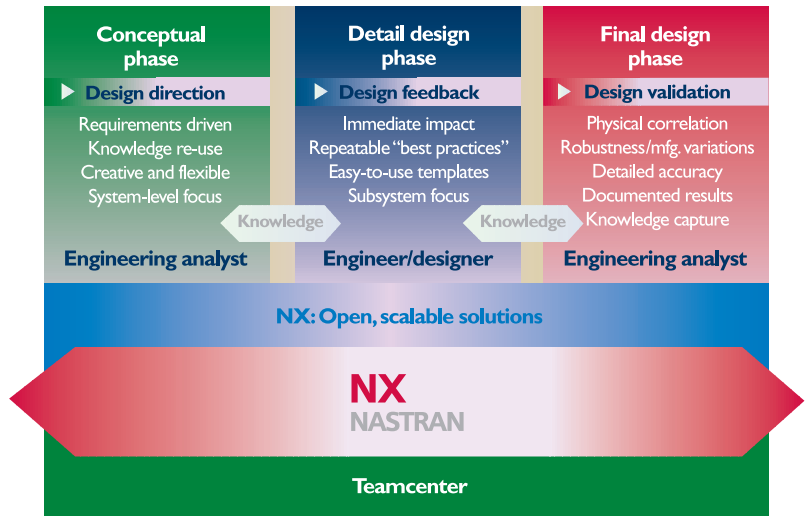

- ▶ **NX Flow and NX Advanced Flow Simulation:** A complete suite of CFD simulation capabilities available as add-ons in the NX Advanced Simulation environment.
- ▶ **NX Thermal and NX Advanced Thermal Simulation:** A complete suite of thermal simulation capabilities available as add-ons within the NX Advanced Simulation environment.
- ▶ **NX Electronic Systems Cooling Simulation:** An integrated solution that enables the evaluation of the cooling effects of airflow around enclosed, densely packed heat-generating electronics systems used in many industries.
- ▶ **NX Space Systems Thermal Simulation:** An integrated solution that enables the evaluation of complex heat transfer characteristics of space systems during both orbital and inter-planetary missions.
- ▶ **Femap:** A multi-CAD, Windows native FEA modeling environment that enables engineers and analysts to handle complex analysis tasks easily, accurately and affordably. Femap is based on the industry-standard Parasolid® software modeling kernel.

### Design productivity applications

- ▶ **NX Design Simulation:** A design-integrated and easy-to-use NX application that enables design engineers to quickly evaluate the structural performance characteristics of 3D product design concepts earlier in the development process.
- ▶ **NX Motion Simulation:** A design-integrated environment for evaluating the kinematic and dynamic performance of new product designs.
- ▶ **NX Simulation Process Studio:** Robust capabilities that allow in-house CAE experts to rapidly develop best practices wizards for enterprise-wide usage minimizing the need to rely on external consultancy services.

## The NX advantage

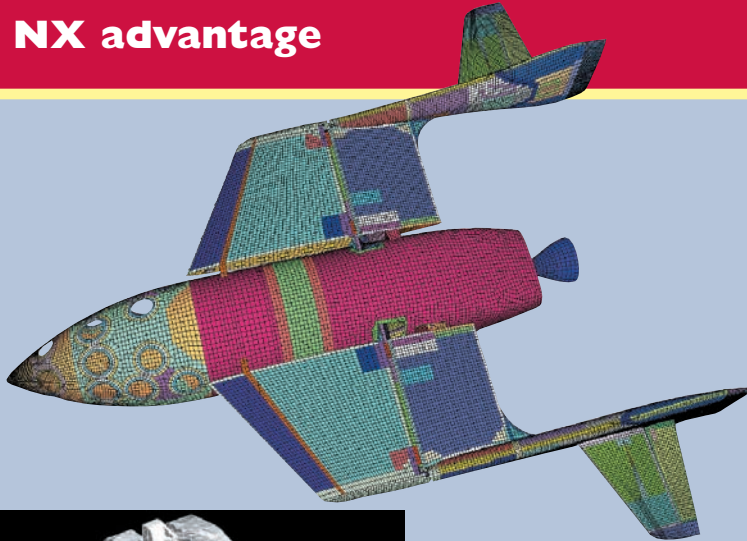

Throughout its broad product application suite, NX leverages key attributes that help companies achieve business objectives of waste reduction, quality improvement, shorter cycle times and greater product innovation. These unique attributes directly support business process initiatives aimed at transforming product development:

- ▶ **Managed development environment**  
NX solutions include fully integrated, synchronized management of all product data and process knowledge to transform product development with a structured collaborative environment.
- ▶ **Unified product development solution**  
Seamless integration of NX applications rapidly propagates changes of product and process information, replacing point solutions with a unified development system, from concept to manufacturing.
- ▶ **Knowledge-driven automation**  
With NX, companies can apply product and process knowledge across all elements of product development to automate processes and maximize re-use.
- ▶ **Simulation, validation and optimization**  
Comprehensive simulation and validation tools in NX automatically check performance and manufacturability at every step of the development process for closed-loop, continuous, repeatable validation.
- ▶ **System-based modeling**  
NX structured conceptual models standardize design practices and allow rapid creation of variants, transforming development from component-based design to a systems engineering approach.

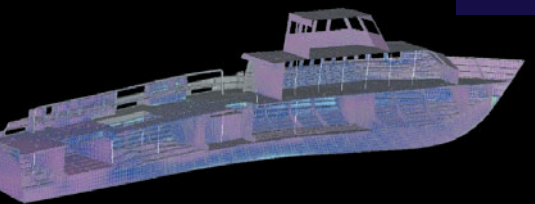
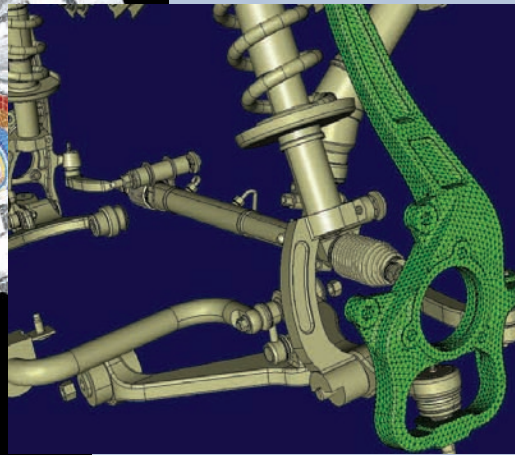
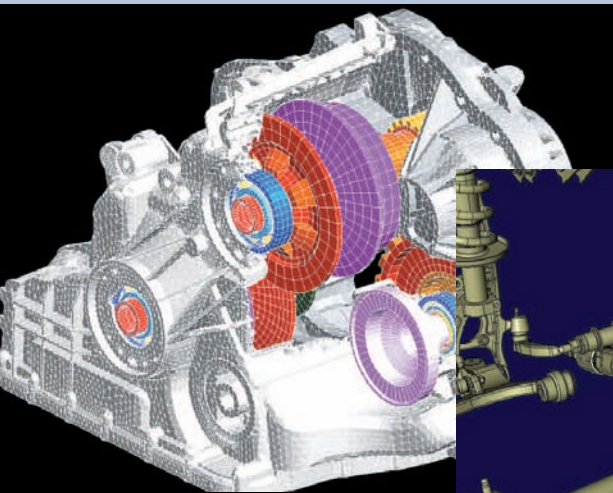

## About Siemens PLM Software

Siemens PLM Software, a business unit of the Siemens Industry Automation Division, is a leading global provider of product lifecycle management (PLM) software and services with nearly six million licensed seats and 56,000 customers worldwide. Headquartered in Plano, Texas, Siemens PLM Software works collaboratively with companies to deliver open solutions that help them turn more ideas into successful products. For more information on Siemens PLM Software products and services, visit [www.siemens.com/plm](http://www.siemens.com/plm).

### Siemens PLM Software

#### Headquarters

Granite Park One  
5800 Granite Parkway  
Suite 600  
Plano, TX 75024  
USA  
972 987 3000  
Fax 972 987 3398

#### Americas

Granite Park One  
5800 Granite Parkway  
Suite 600  
Plano, TX 75024  
USA  
800 498 5351  
Fax 972 987 3398

#### Europe

3 Knoll Road  
Camberley  
Surrey GU15 3SY  
United Kingdom  
44 (0) 1276 702000  
Fax 44 (0) 1276 702130

#### Asia-Pacific

Suites 6804-8, 68/F  
Central Plaza  
18 Harbour Road  
WanChai  
Hong Kong  
852 2230 3333  
Fax 852 2230 3210

[www.siemens.com/plm](http://www.siemens.com/plm)

© 2009 Siemens Product Lifecycle Management Software Inc. All rights reserved. Siemens and the Siemens logo are registered trademarks of Siemens AG. Teamcenter, NX, Solid Edge, Tecnomatix, Parasolid, Femap, I-deas and Velocity Series are trademarks or registered trademarks of Siemens Product Lifecycle Management Software Inc. or its subsidiaries in the United States and in other countries. All other logos, trademarks, registered trademarks or service marks used herein are the property of their respective holders.

1108-W 19 8/09